

**20.40.1312.00**

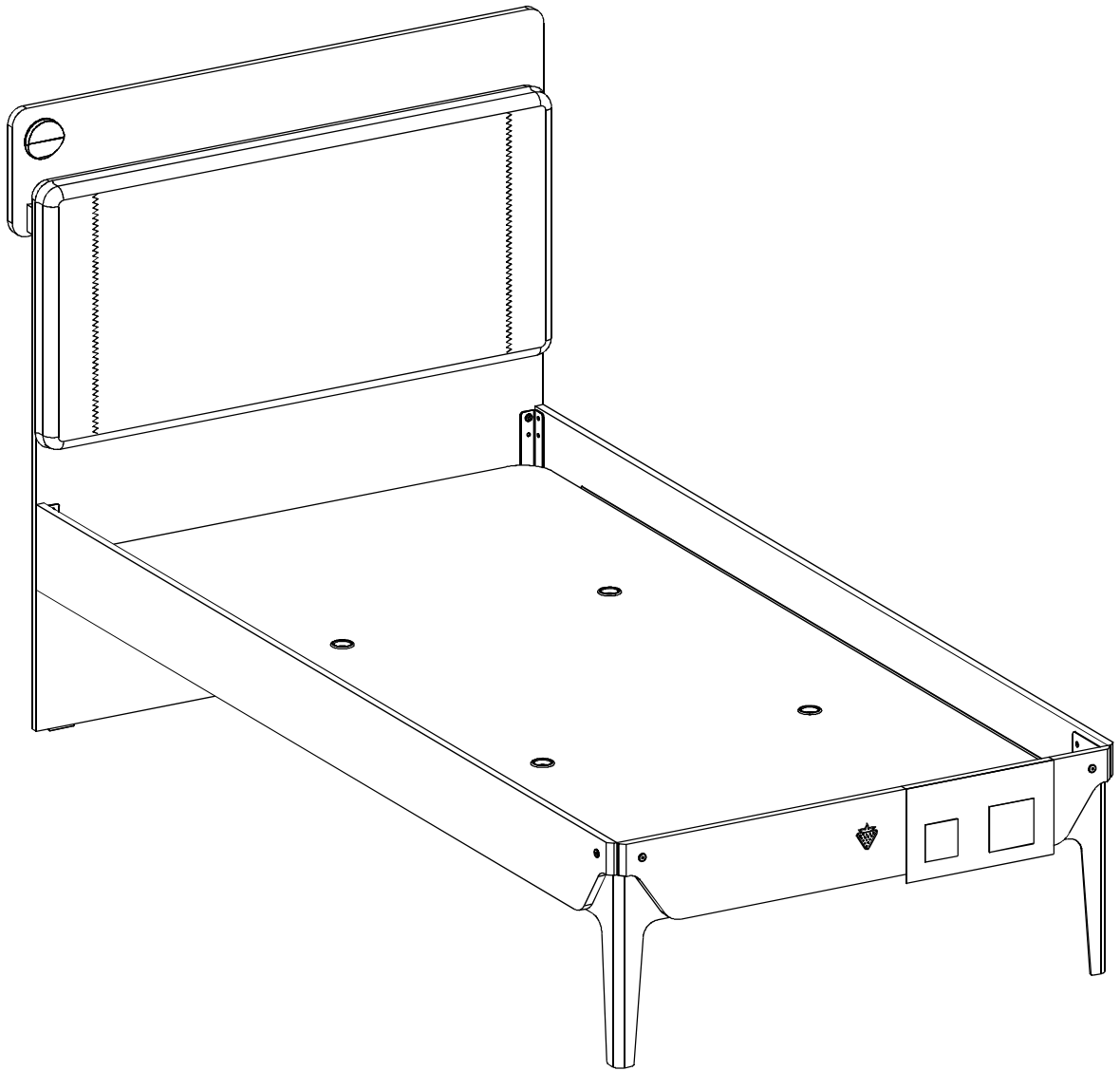

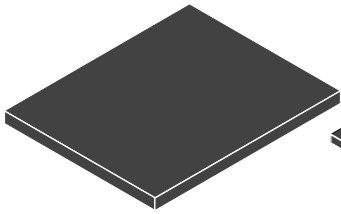

4 / 1

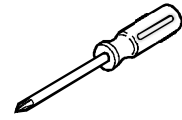
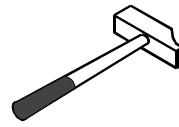
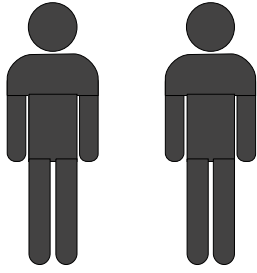
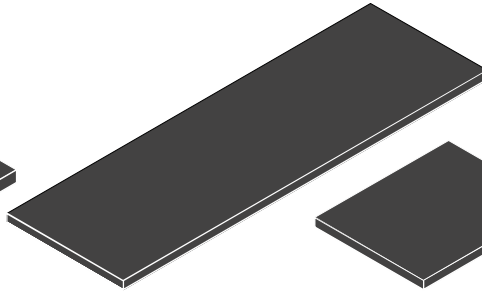

4 / 2

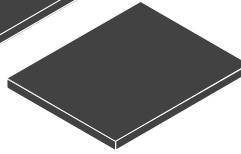

4 / 3

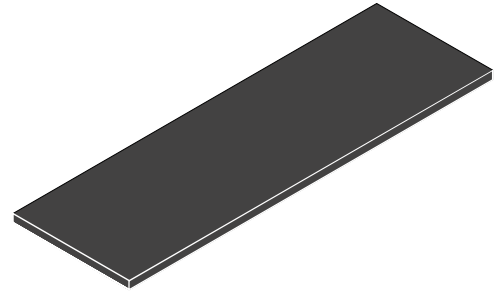

4 / 4

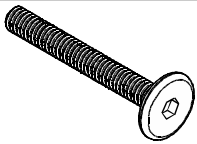

13.50.01.057 x 3  
M6X50

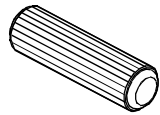

13.01.01.111 x 4



13.02.01.017 x 34

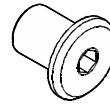

13.07.01.093 x 4

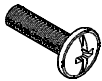

13.03.01.007 x 2

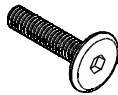

13.03.01.023 x 8  
M6X15

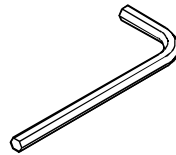

13.07.01.016 x 1

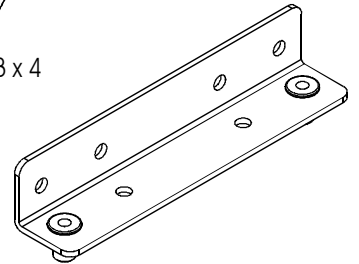

13.07.01.398 x 2



13.03.01.021 x 28

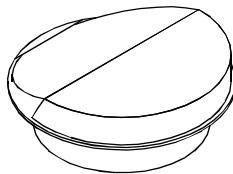

13.15.01.118 x 1

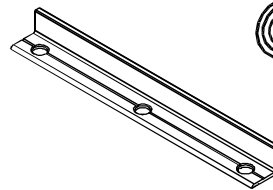

18.40.1312.203 x 4

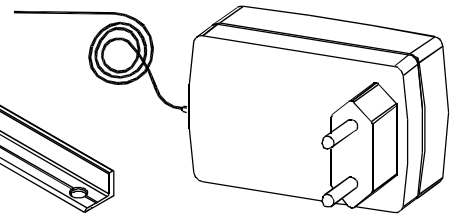

13.15.01.093 x 1

4 / 1

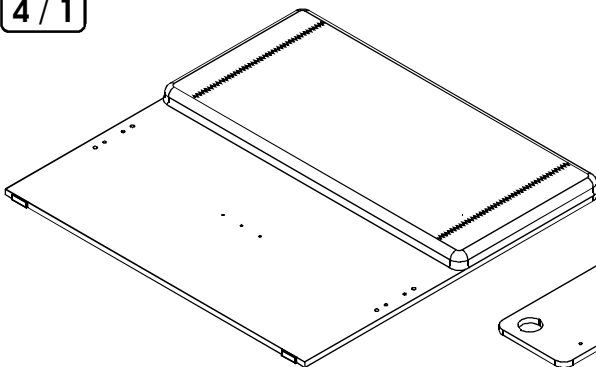

18.40.1312.005 x 1

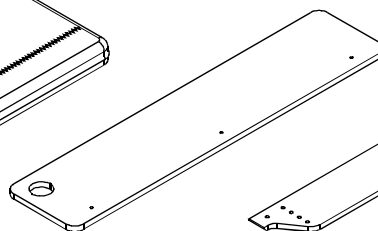

18.40.1312.006 x 1

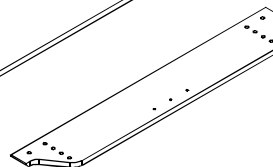

18.40.1312.003 x 1

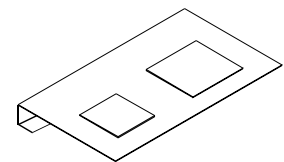

13.10.01.174 x 1

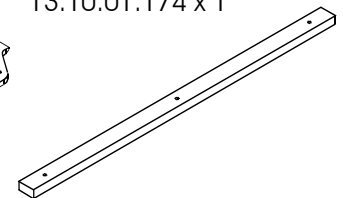

18.40.1312.007 x 1

4 / 2

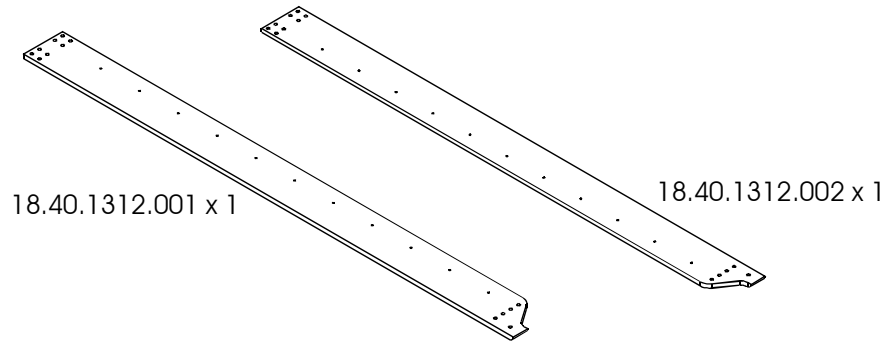

4 / 3

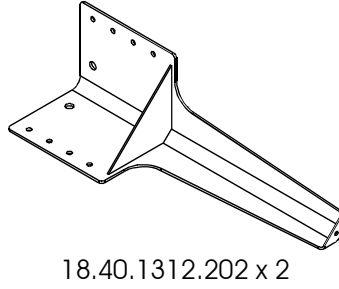

4 / 4

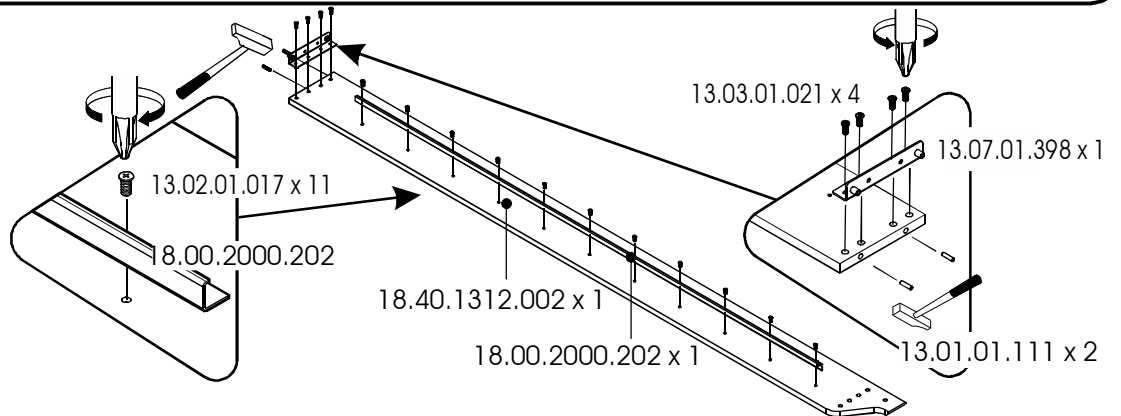
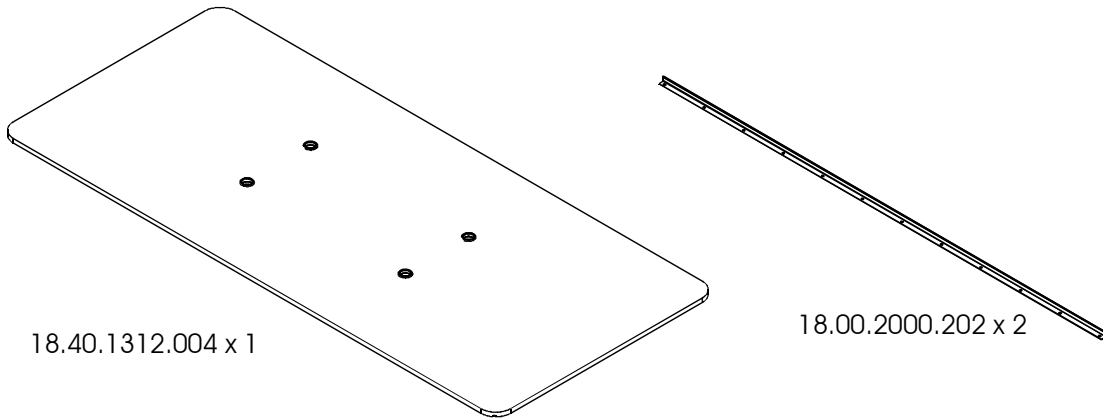

1

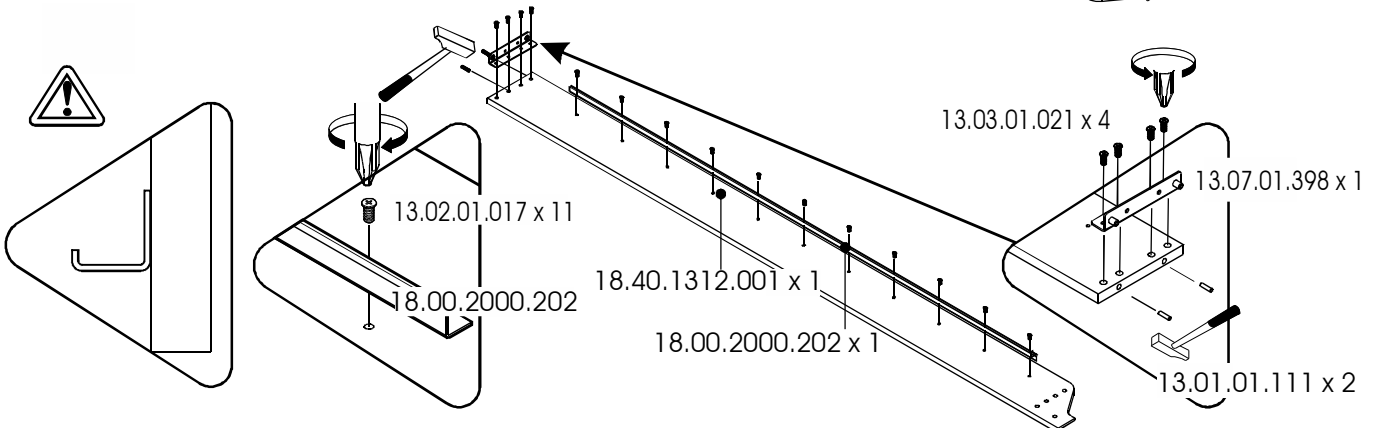

2

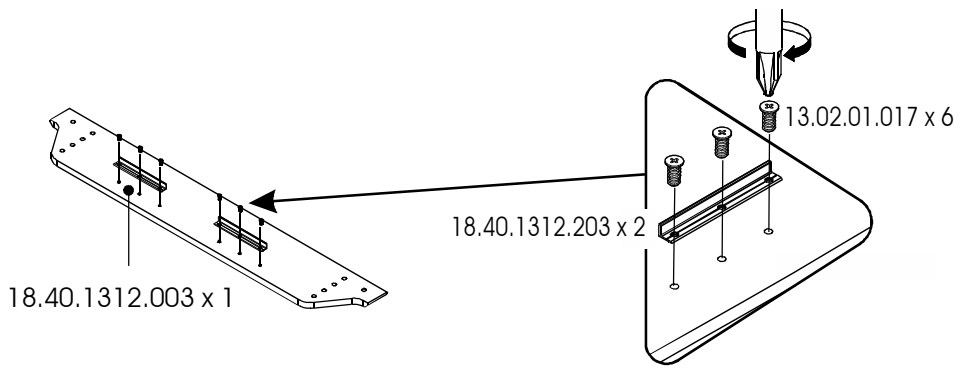

3

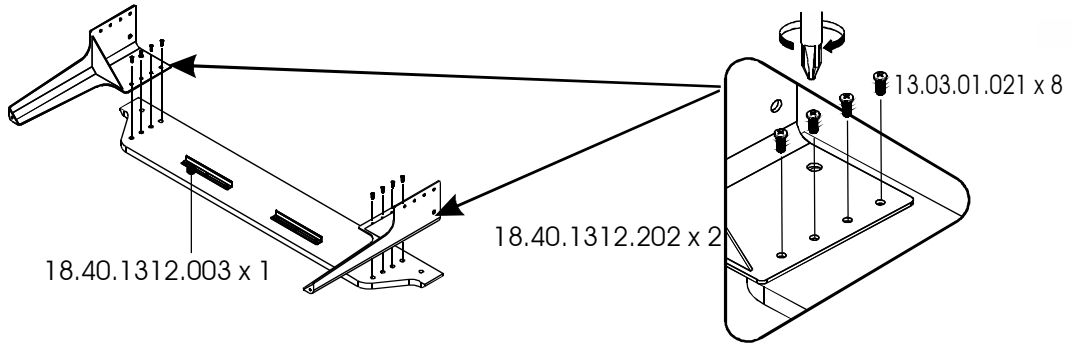

4

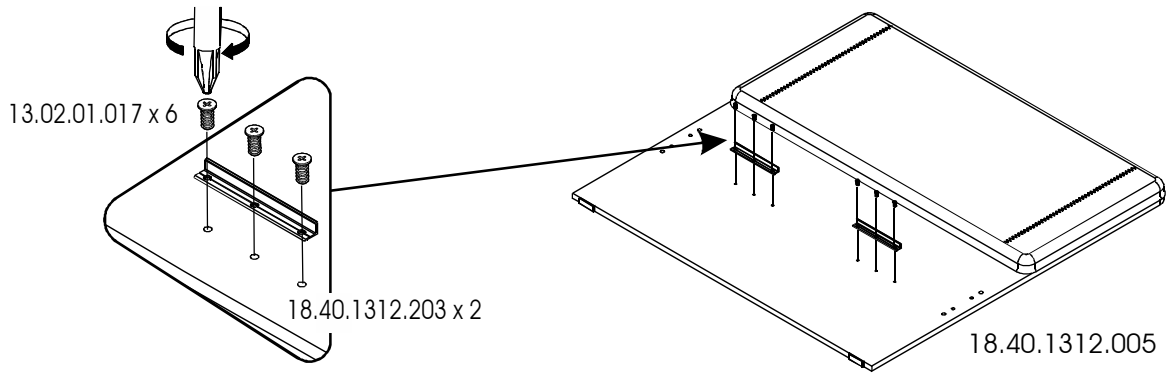

5

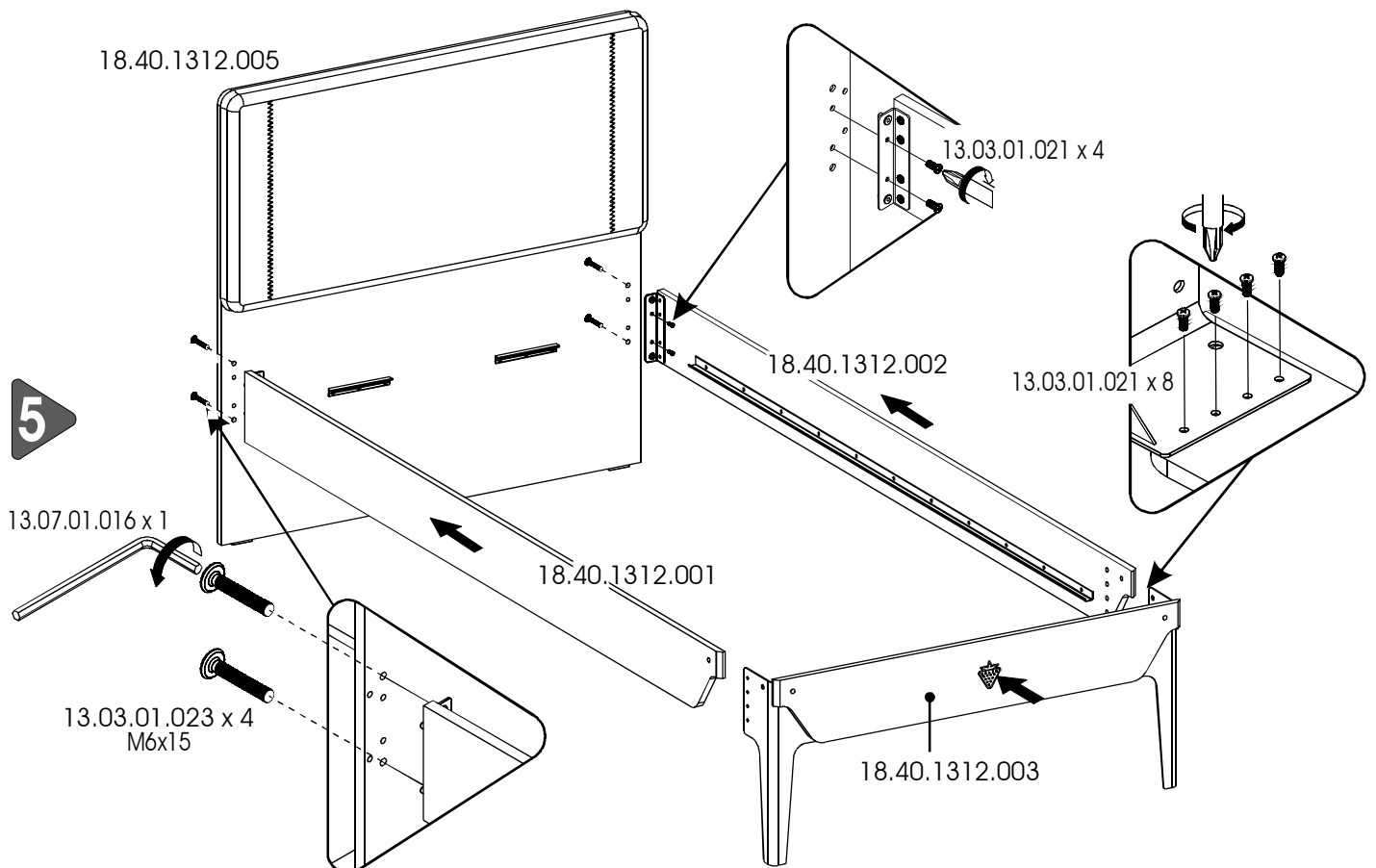

6

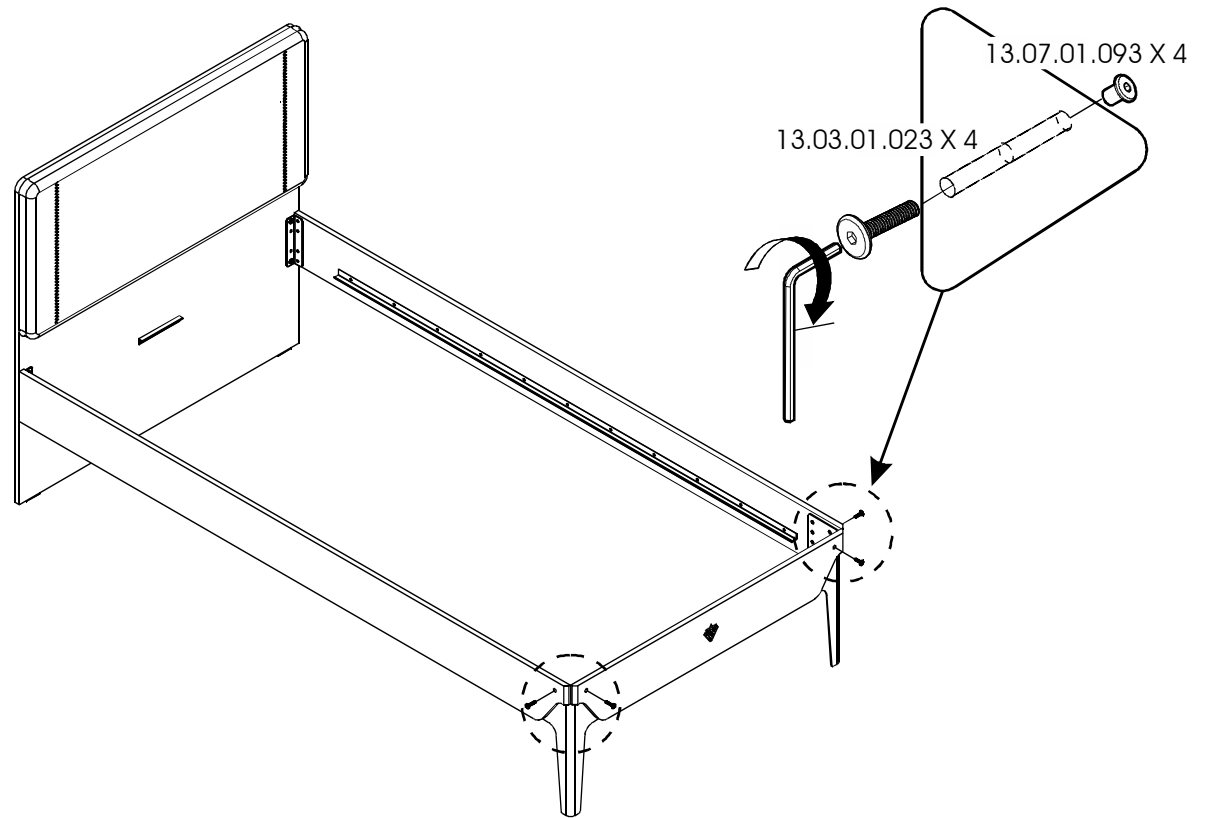

7

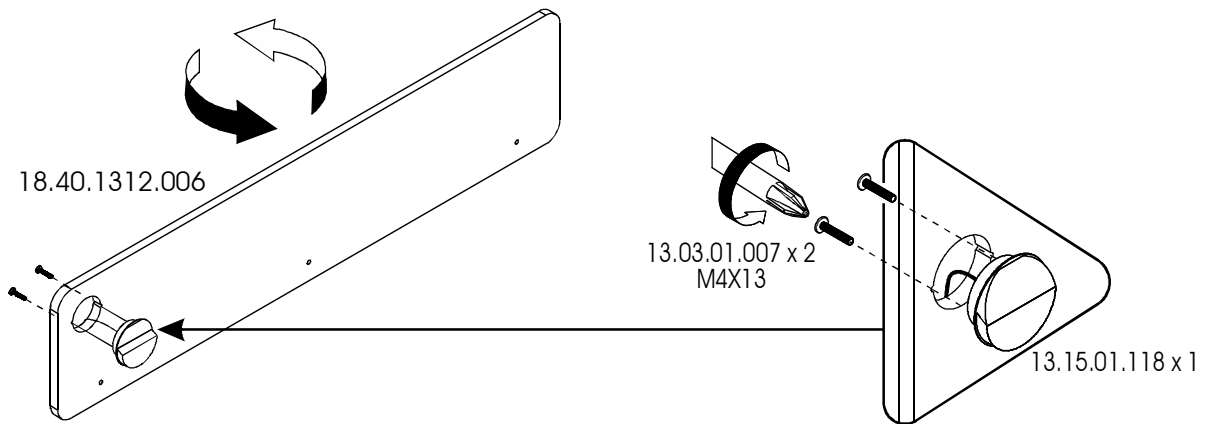

8

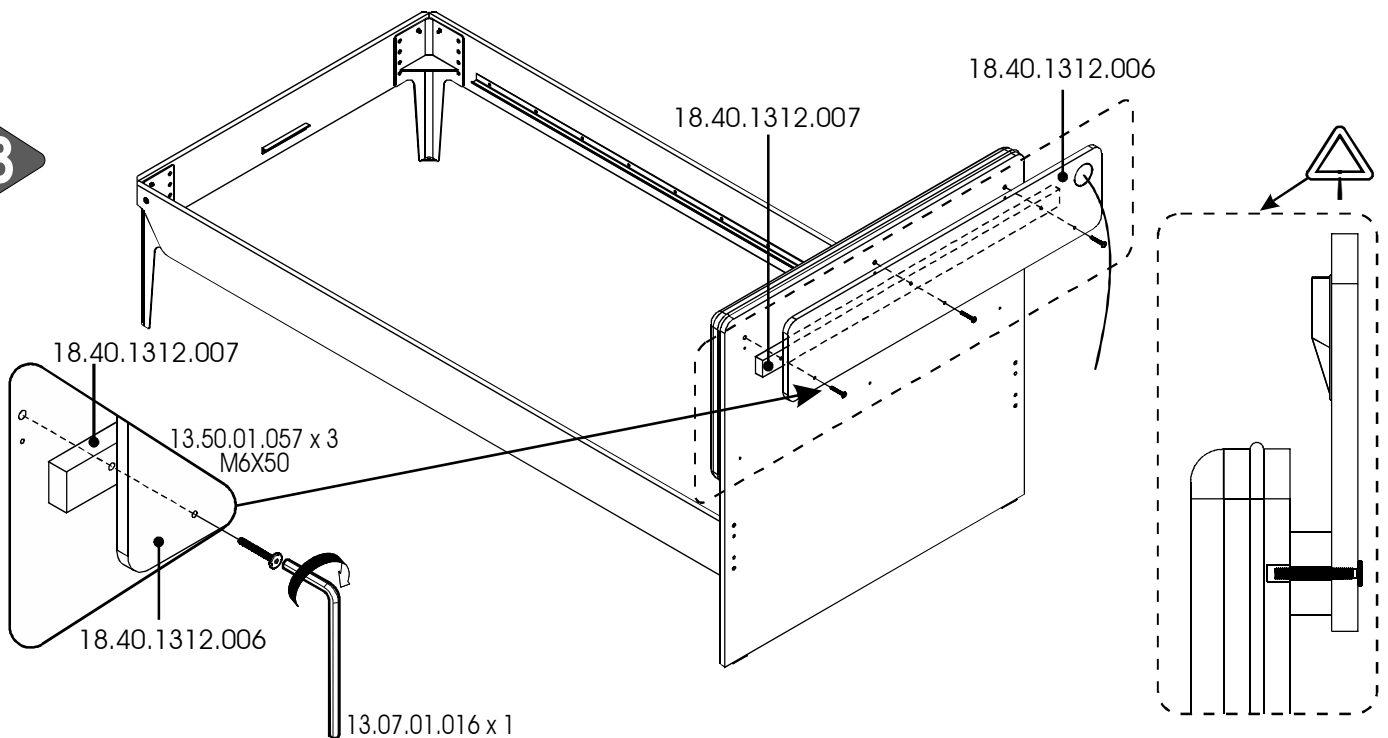

9

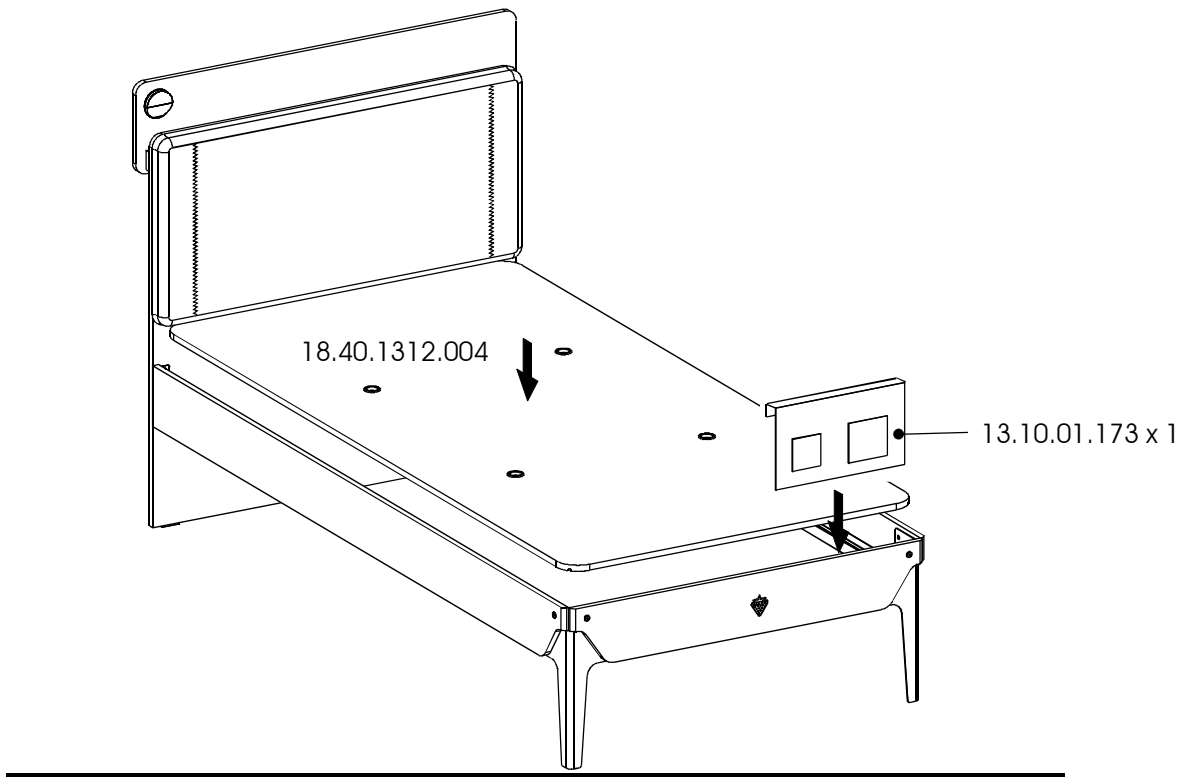

10

