

20.52.1310.00

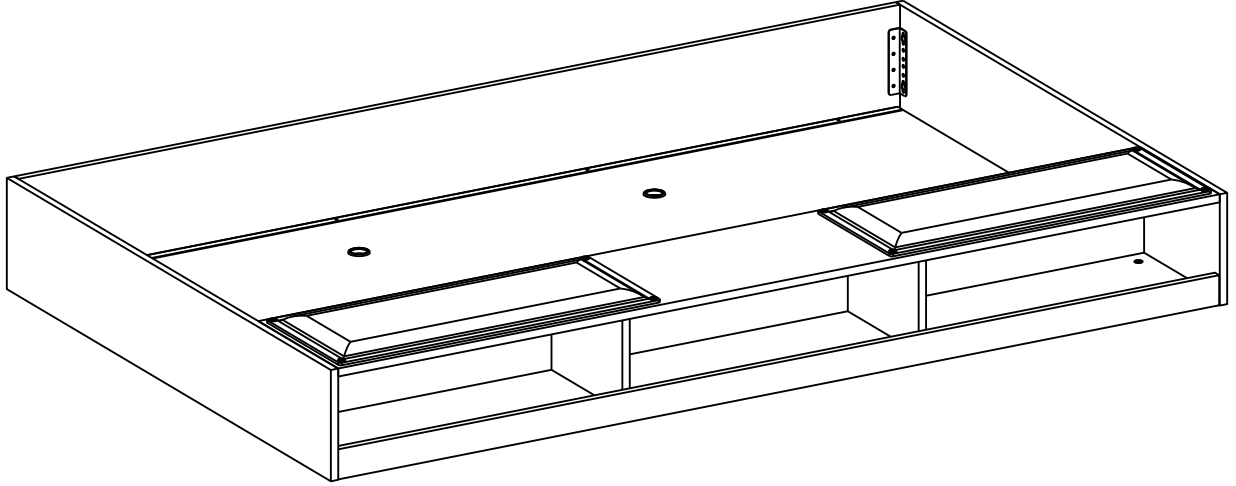

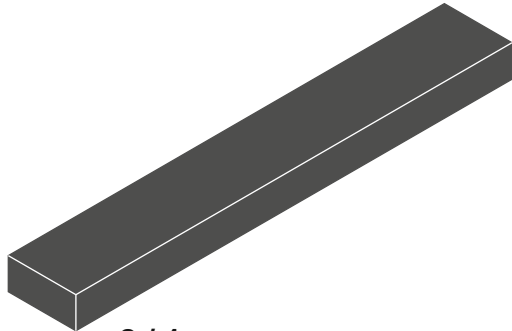

2 / 1

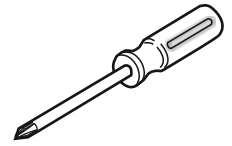
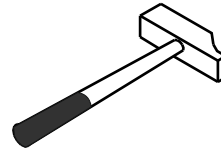
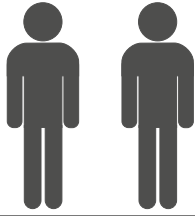
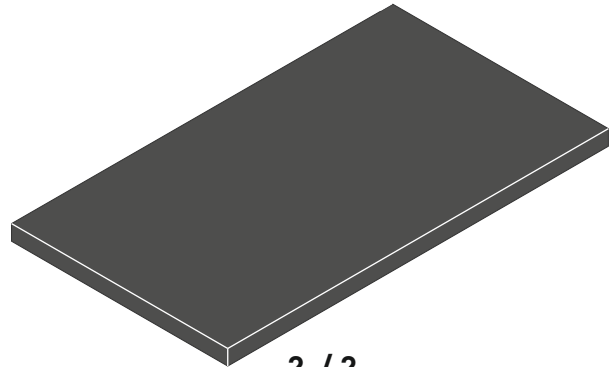

2 / 2

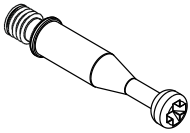

13.07.01.108 x 21



13.07.01.110 x 21

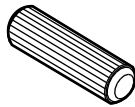

13.01.01.111 x30



13.02.01.004 x 15



13.02.01.017 x 24

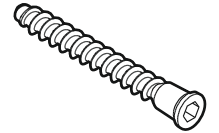

13.02.01.019 x 6



13.01.02.032 x 6



M6 X 13
13.03.01.021 x 8



13.01.01.058 x 21



13.02.01.015 x 8



13.02.01.043 x 8

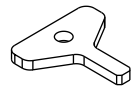

13.07.01.427 x 1

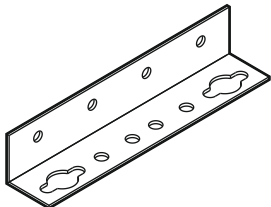

13.07.01.082 x 2

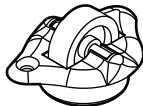

13.01.01.005 x 7

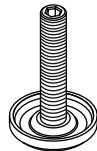

13.07.01.430 x 2



13.07.01.016 x 1

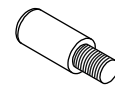

13.07.01.405 x 2

2 / 1

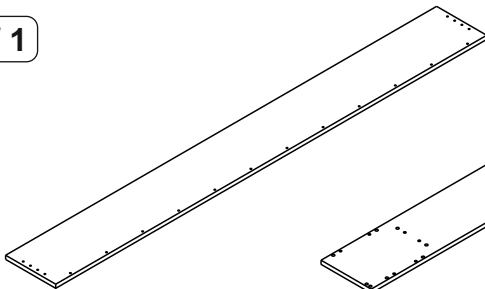

18.52.1310.003 x 1

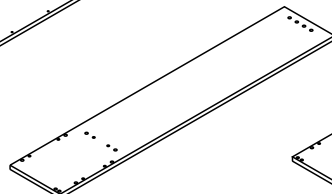

18.52.1310.001 x 1

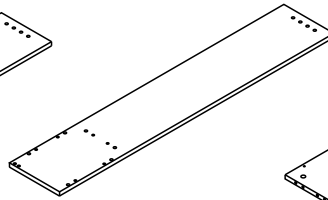

18.52.1310.002 x 1

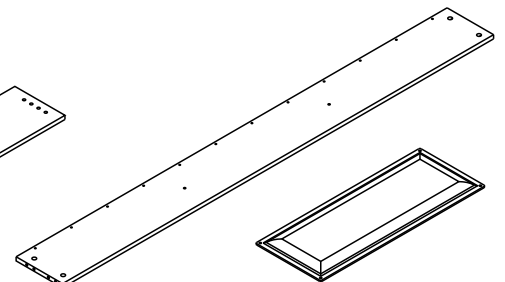

18.52.1310.004 x 1

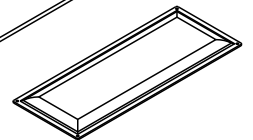

13.10.01.263 x 2

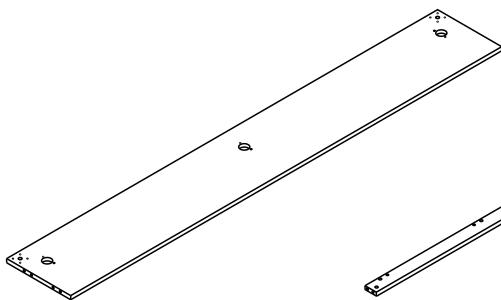

18.52.1310.008 x 1

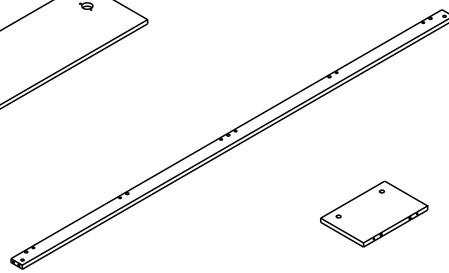

18.52.1310.006 x 1

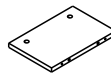

18.52.1310.007 x 2

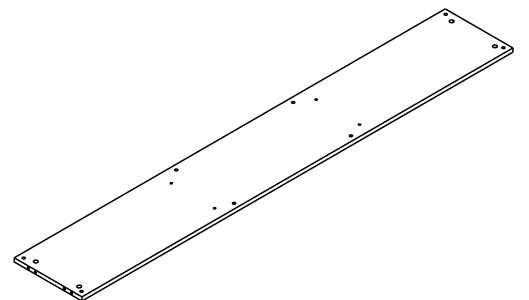

18.52.1310.005 x 1

2 / 2

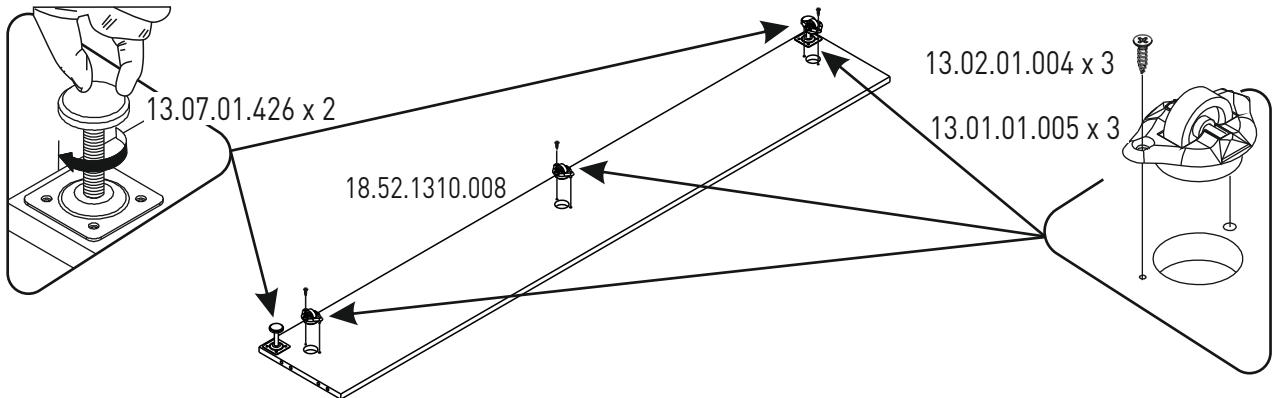
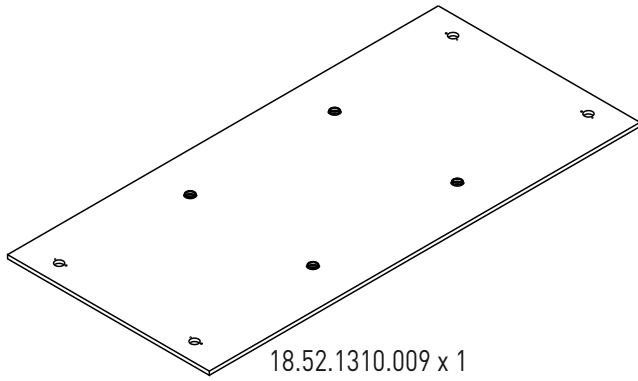

1

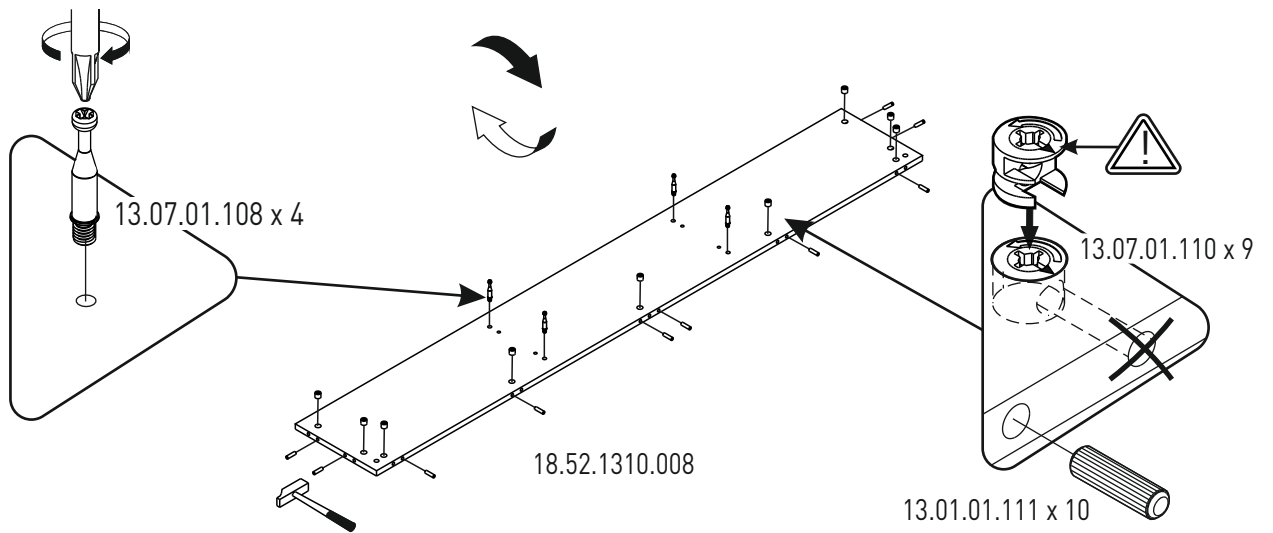

2

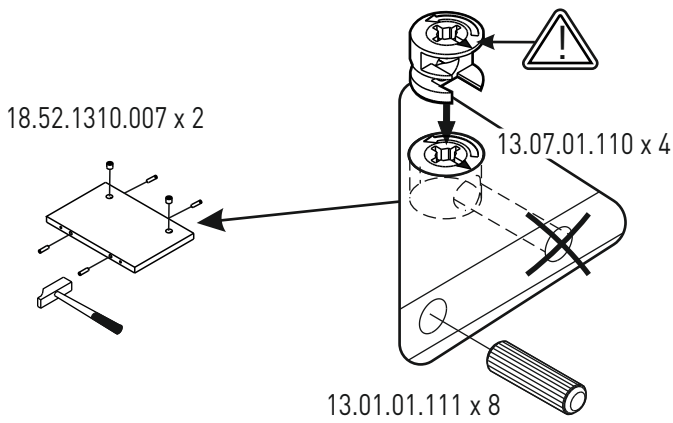

3

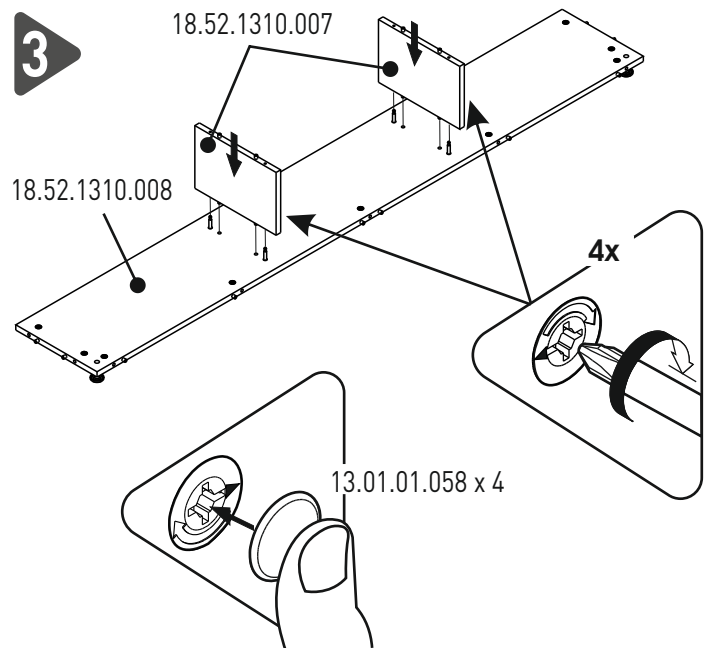

4

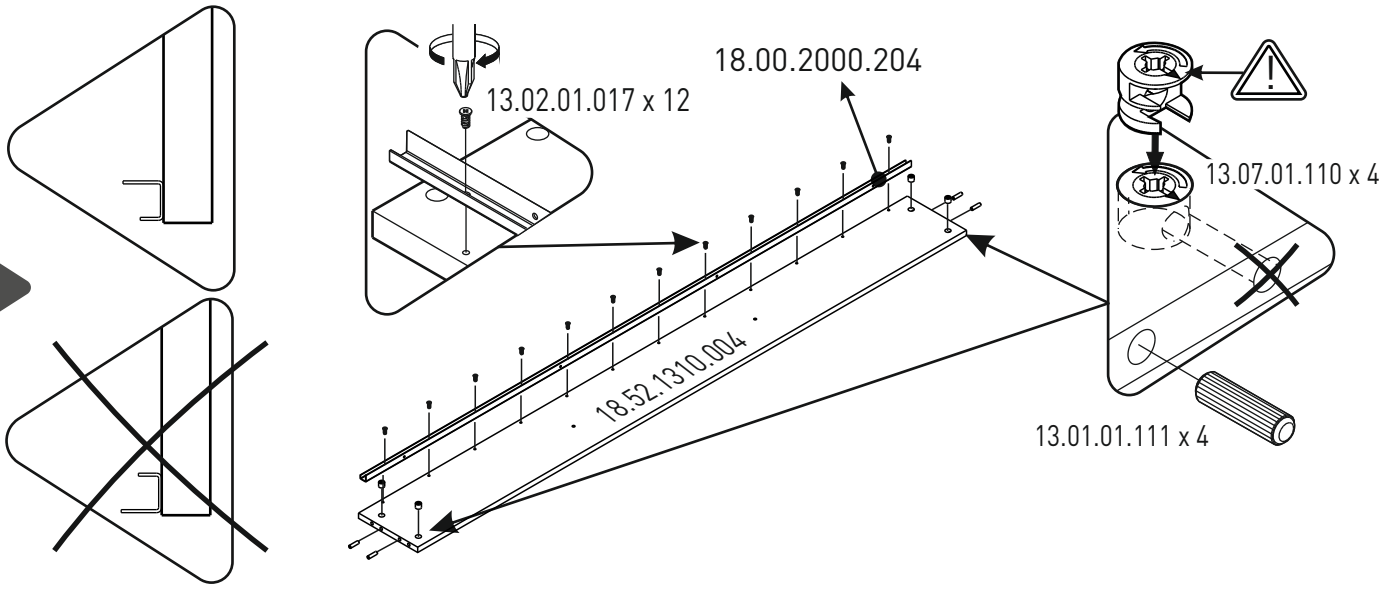

5

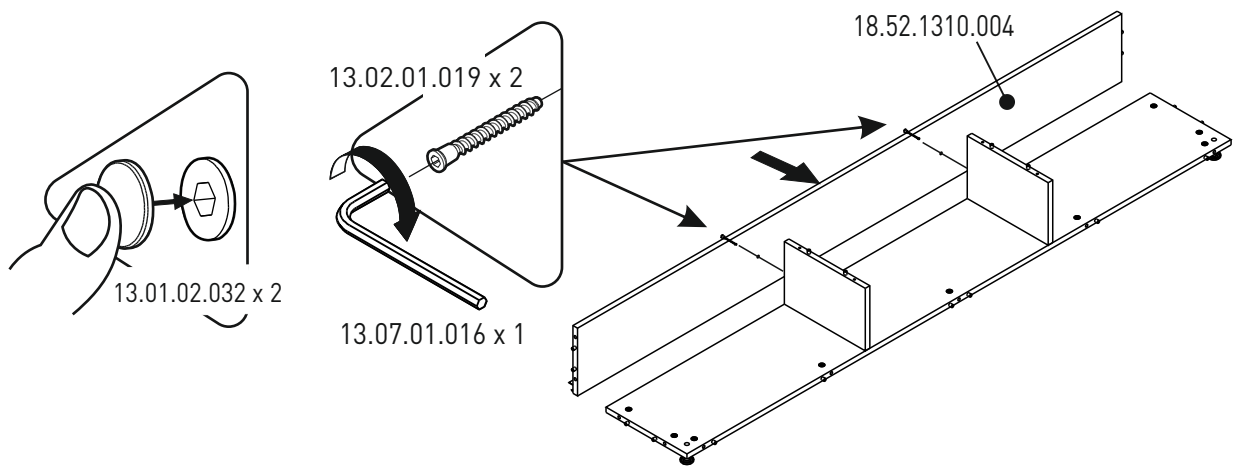

6

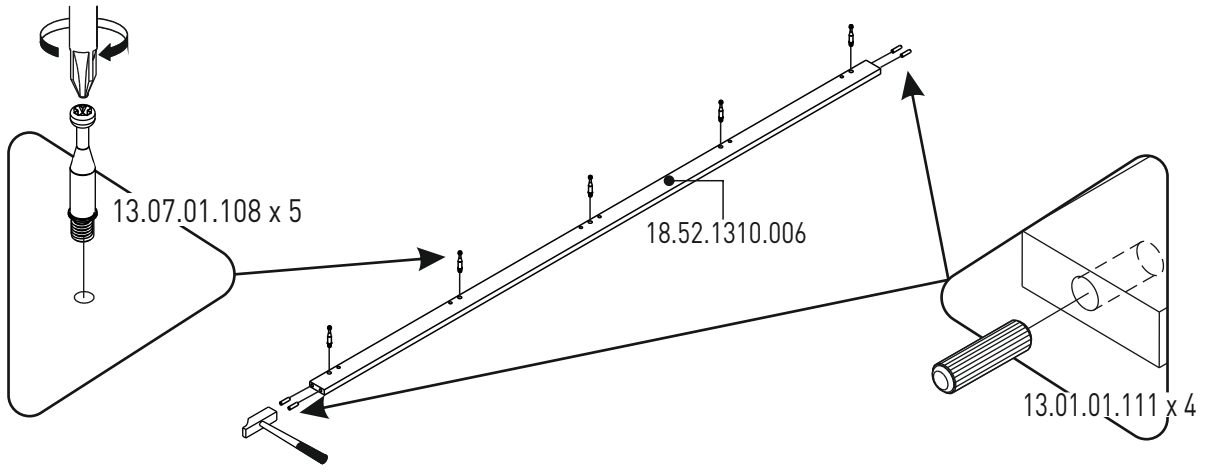

7

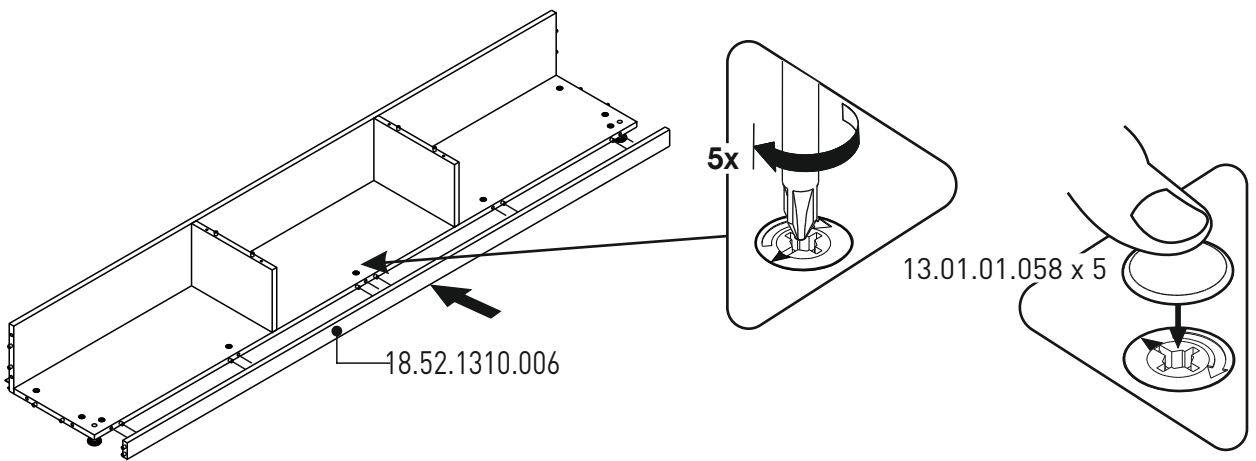

8

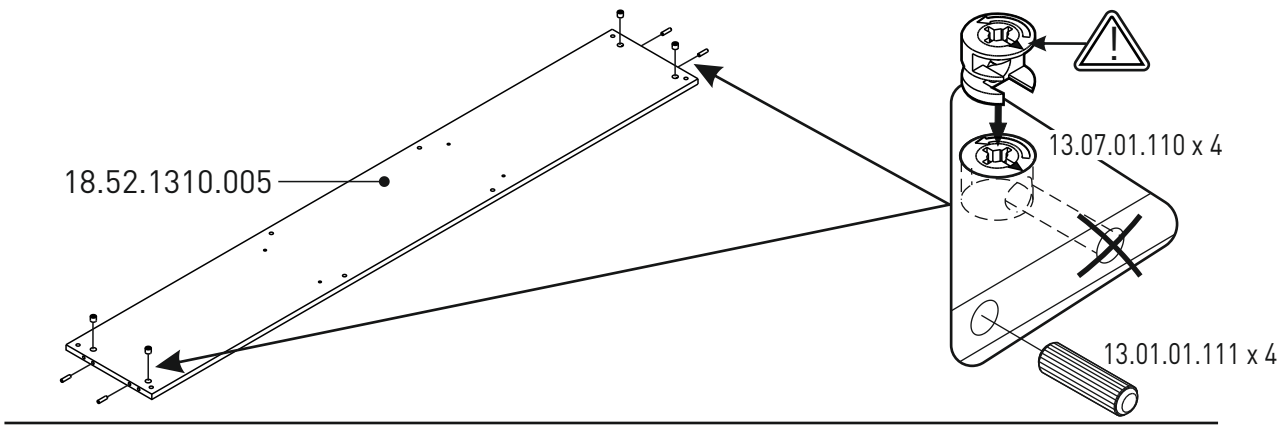

9

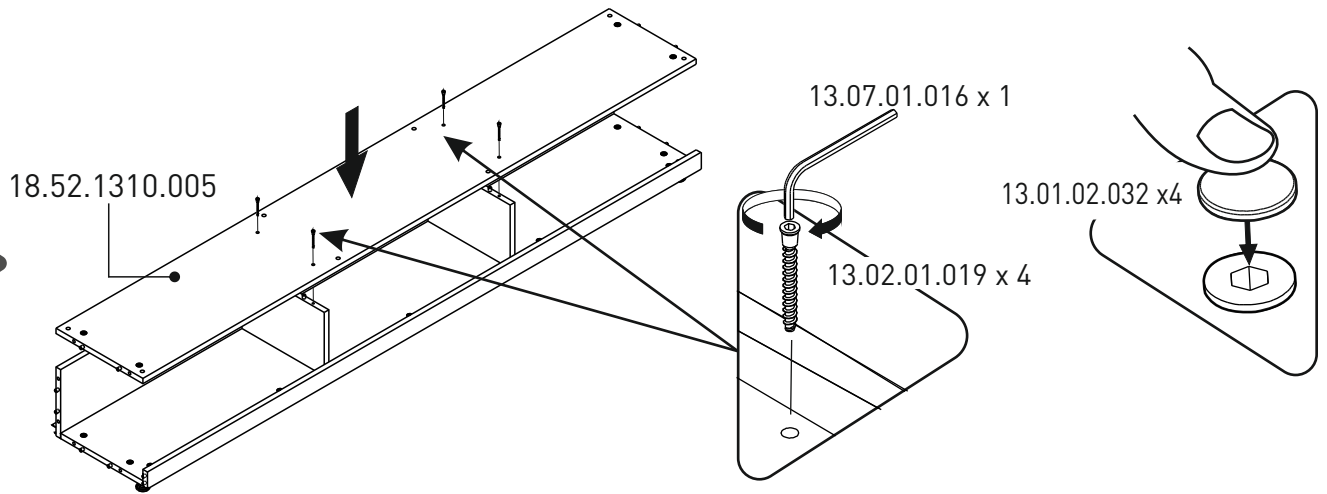

10

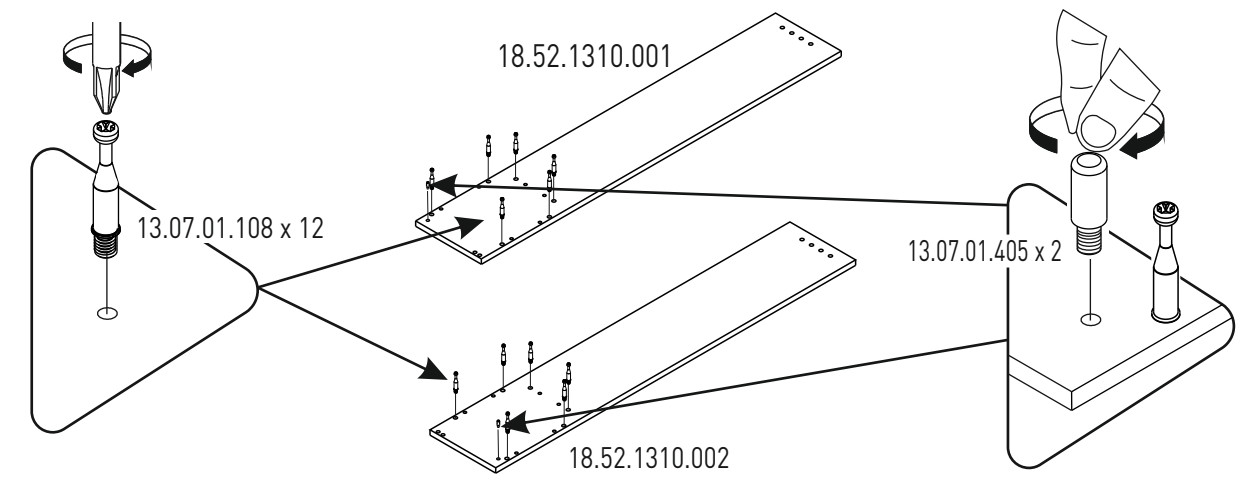

11

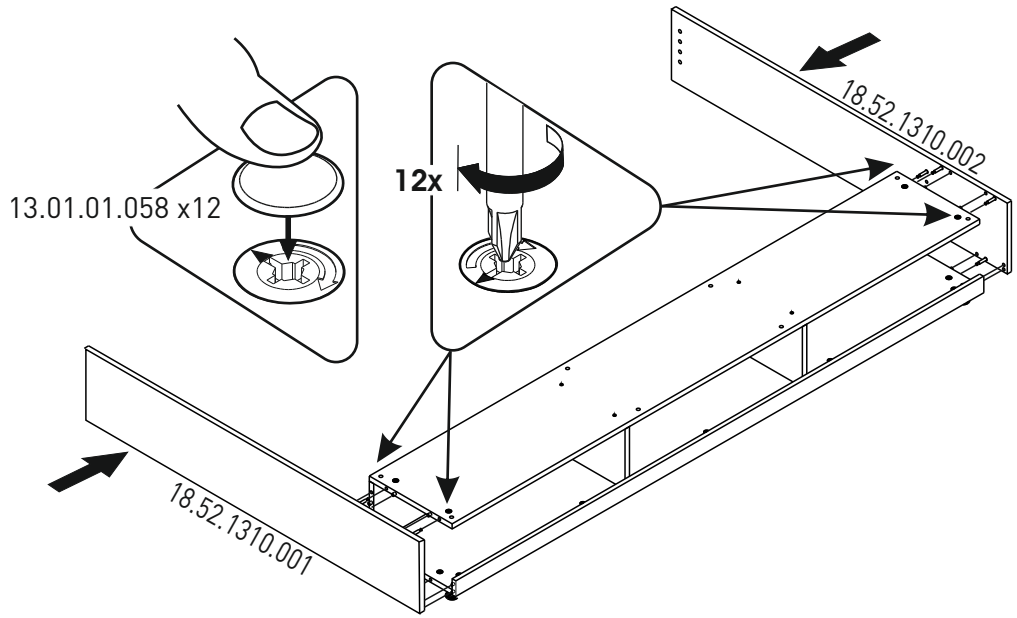

12

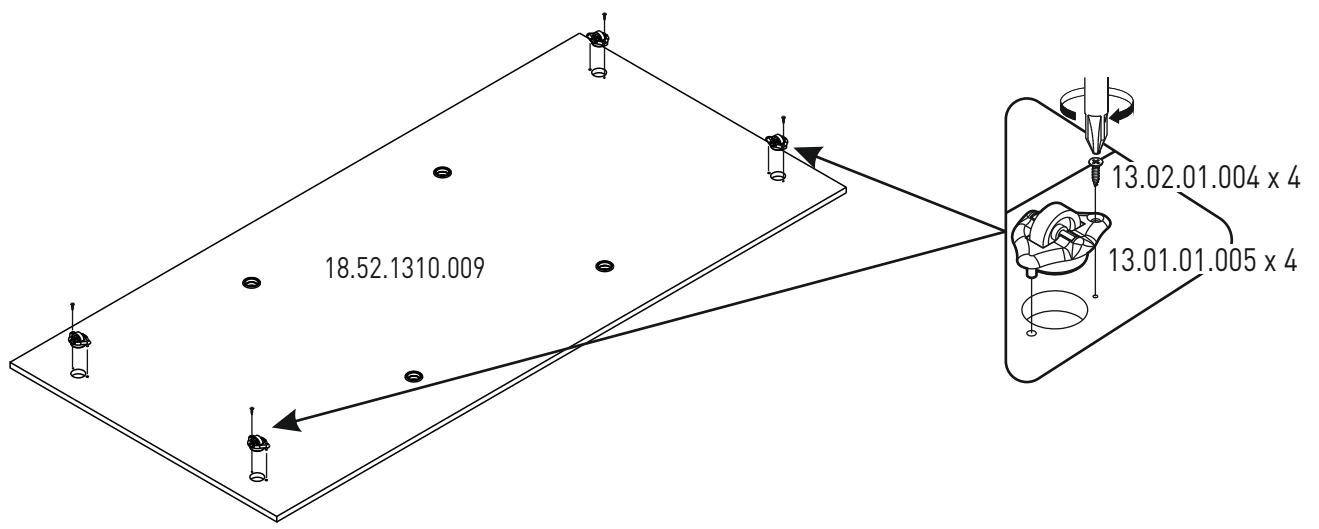

13

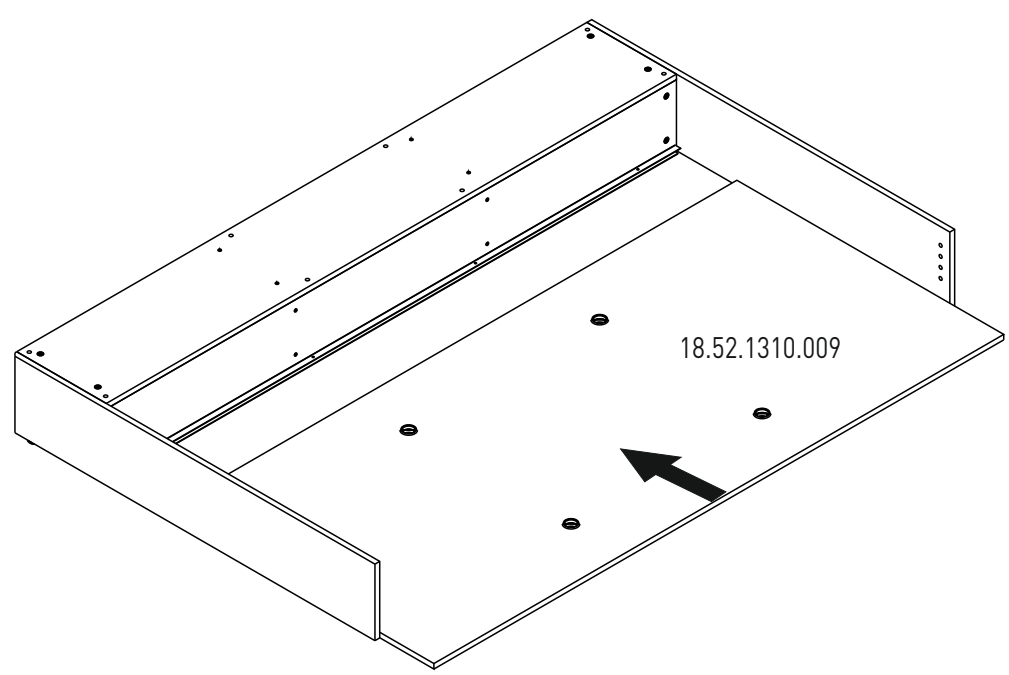

14

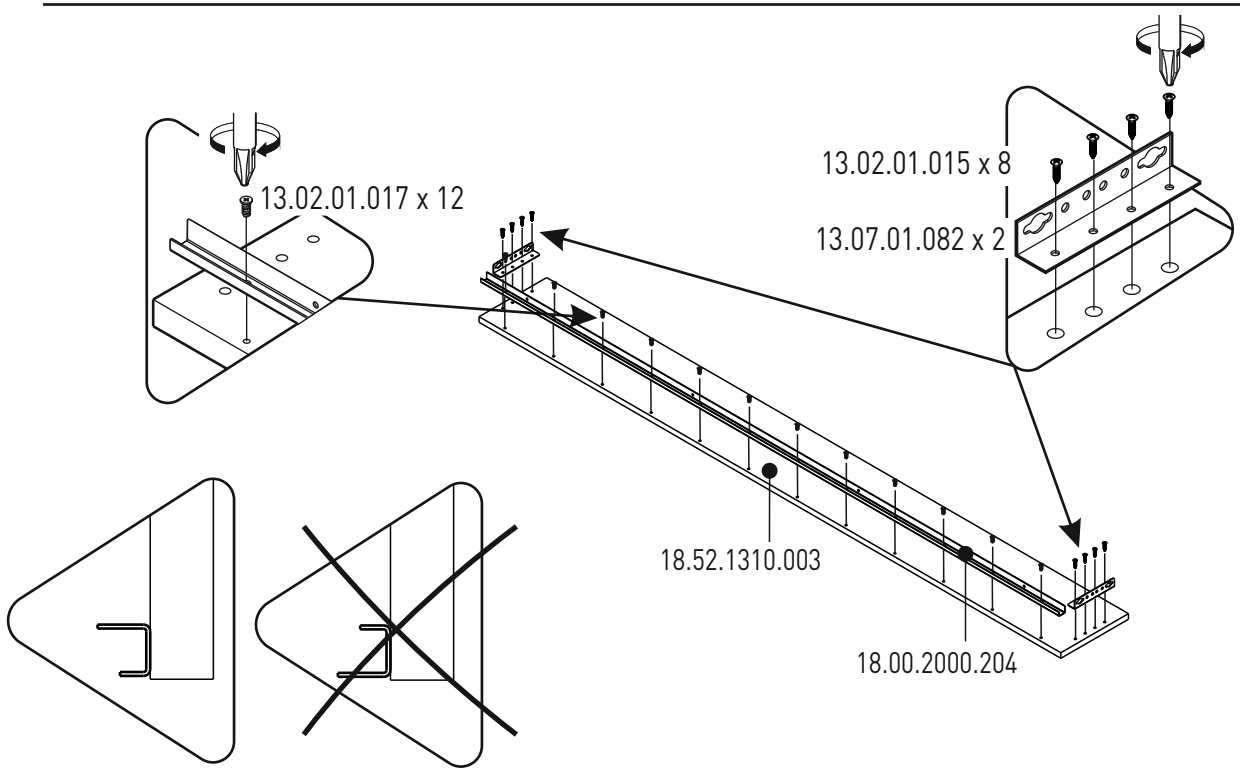

15

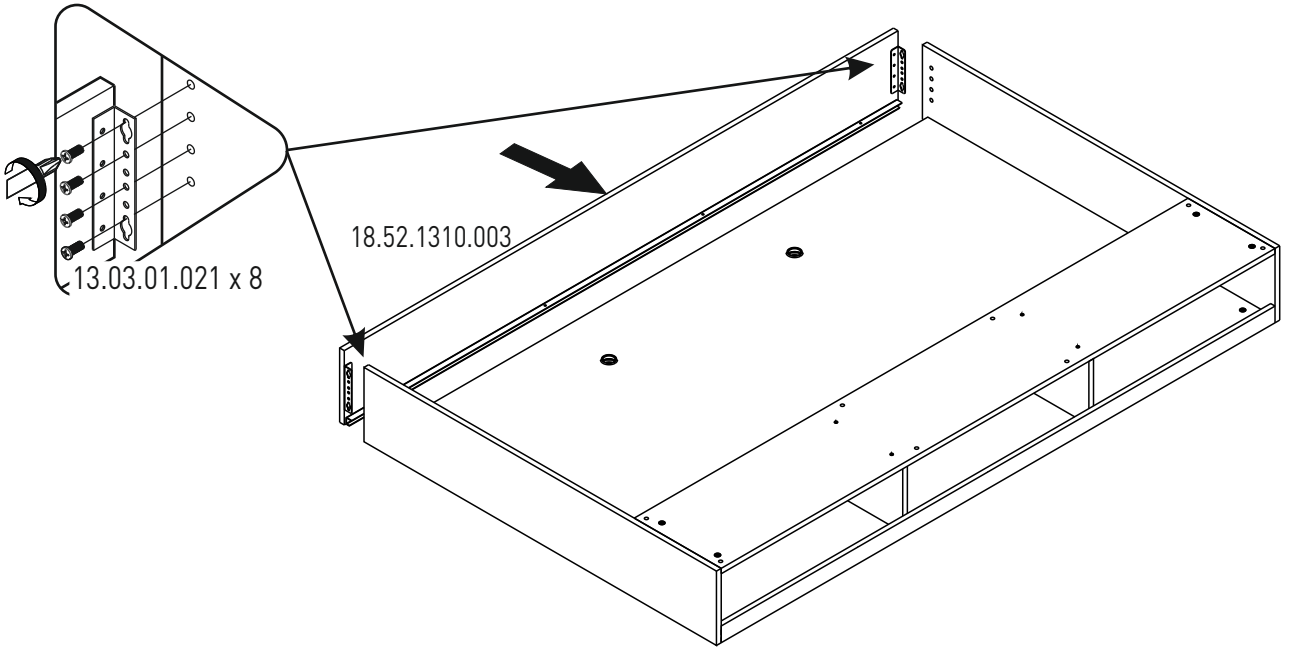

16

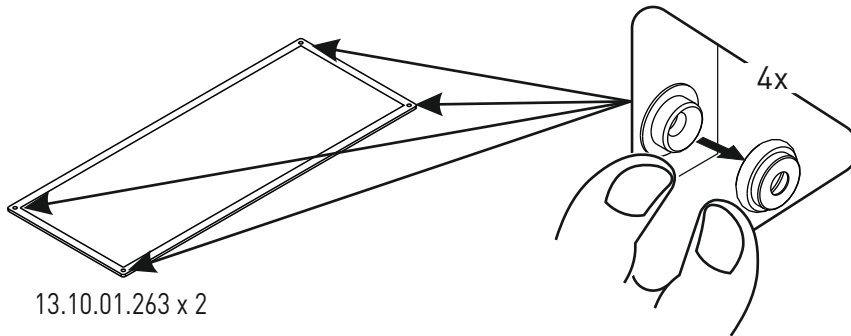

17

