

20.73.1312.00

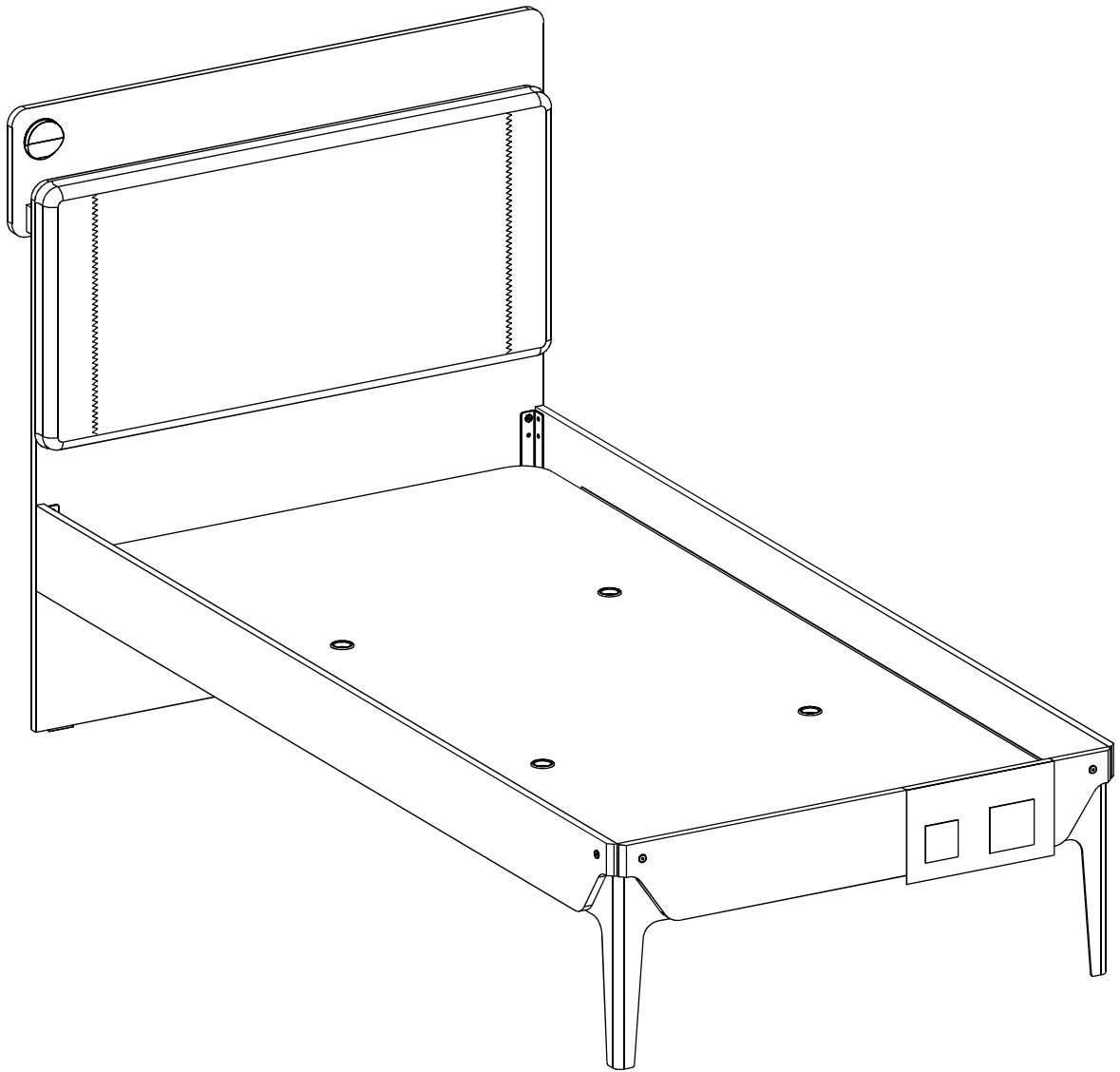

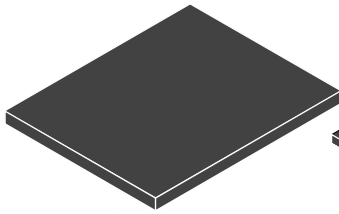

4 / 1

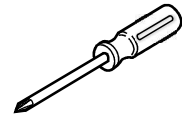
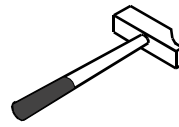
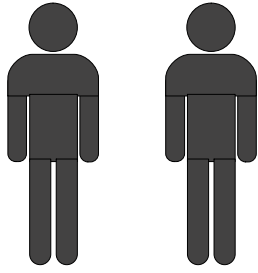
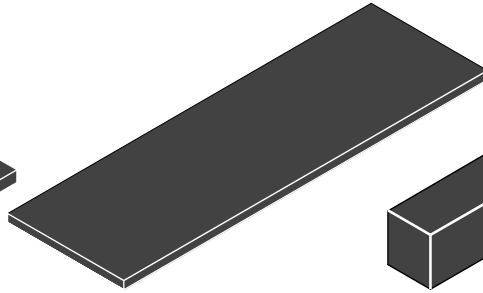

4 / 2

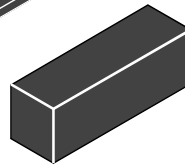

4 / 3

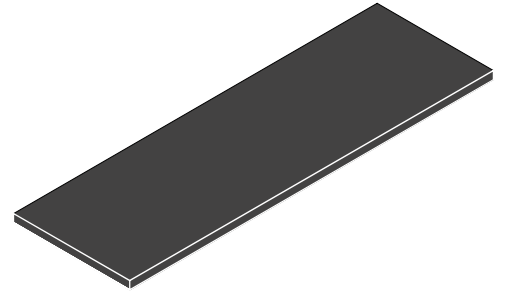

4 / 4

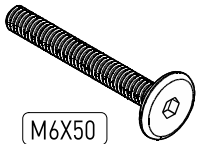

M6X50

13.50.01.057 x 3

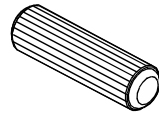

13.01.01.111 x 4



13.02.01.017 x 28

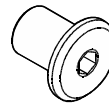

13.07.01.093 x 4



M4X13

13.03.01.007 x 2

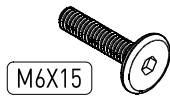

M6X15

13.03.01.023 x 4

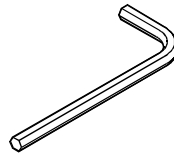

13.07.01.016 x 1

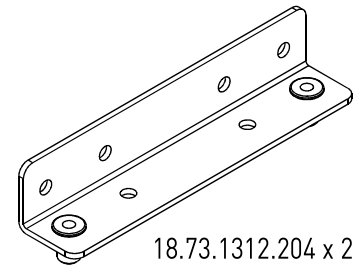

18.73.1312.204 x 2



13.03.01.021 x 20

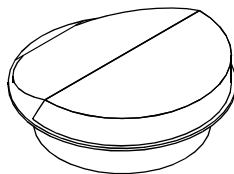

13.15.01.162 x 1

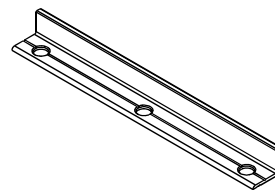

18.73.1312.203 x 2

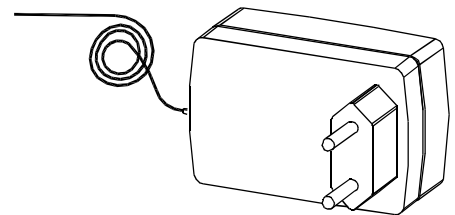

13.15.01.093 x 1

4 / 1

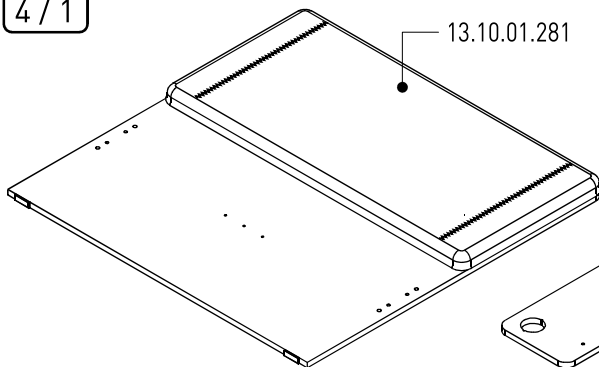

18.73.1312.005 x 1

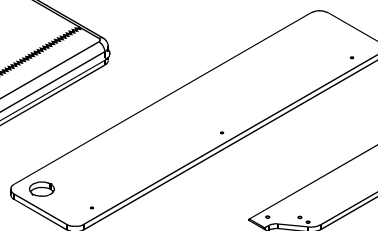

18.73.1312.006 x 1

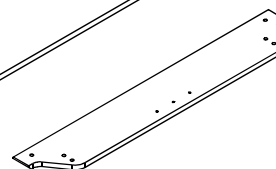

18.73.1312.003 x 1

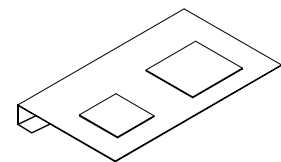

13.10.01.277 x 1

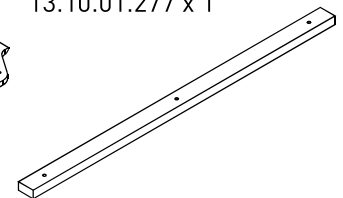

18.73.1312.007 x 1

4/2

18.73.1312.001 x 1

18.73.1312.002 x 1

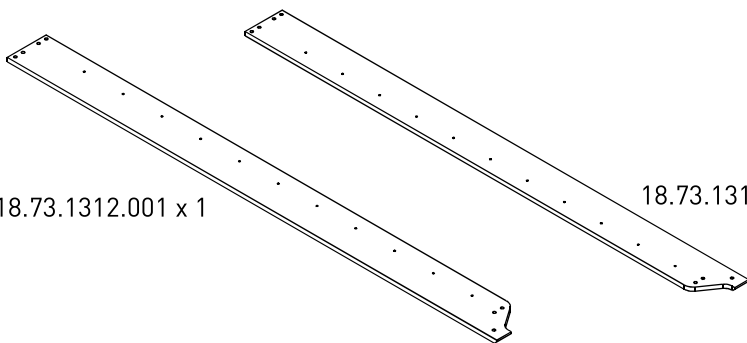

4/3

18.73.1312.202 x 2

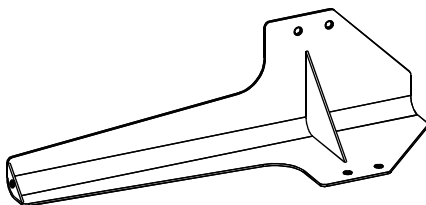

4/4

18.73.1312.004 x 1

18.73.1312.201 x 2

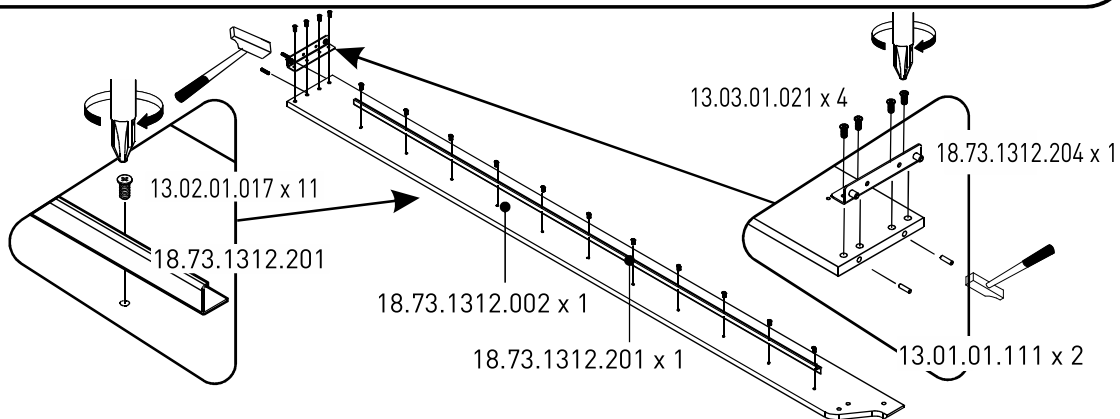
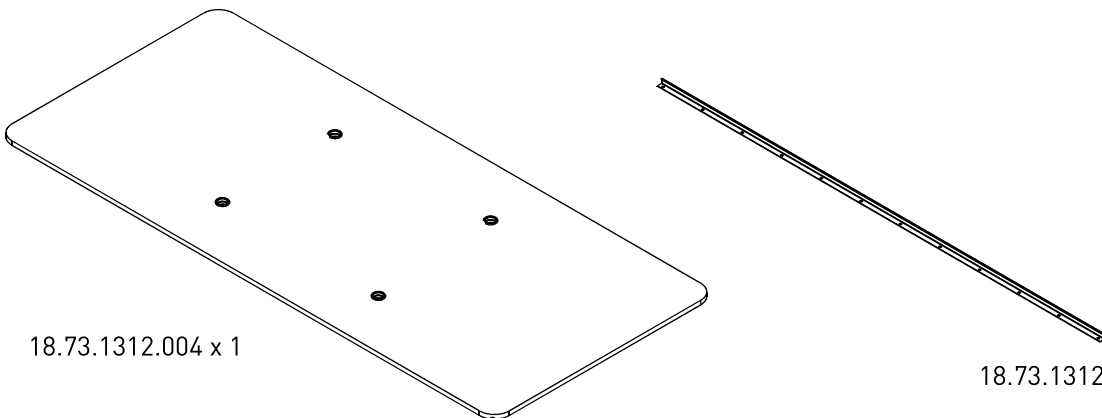

1

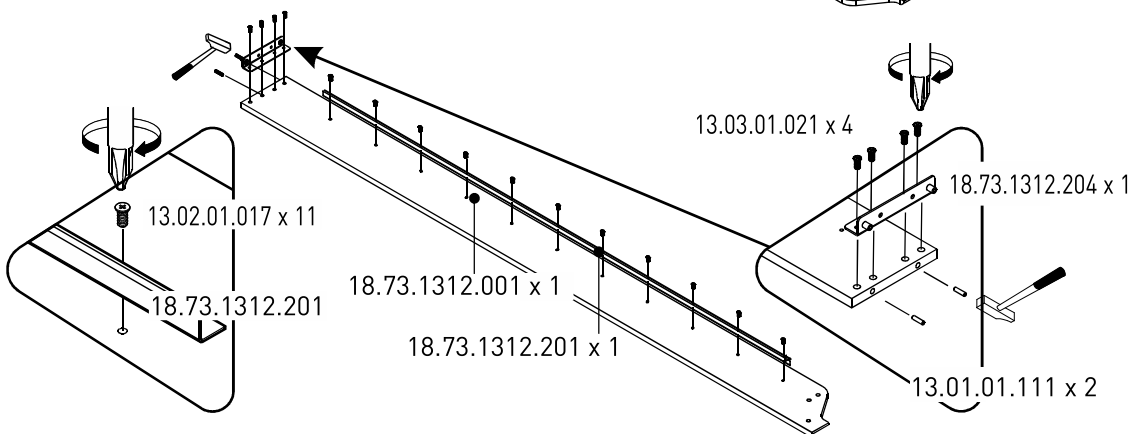
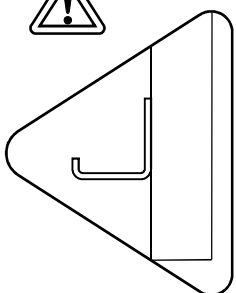

2

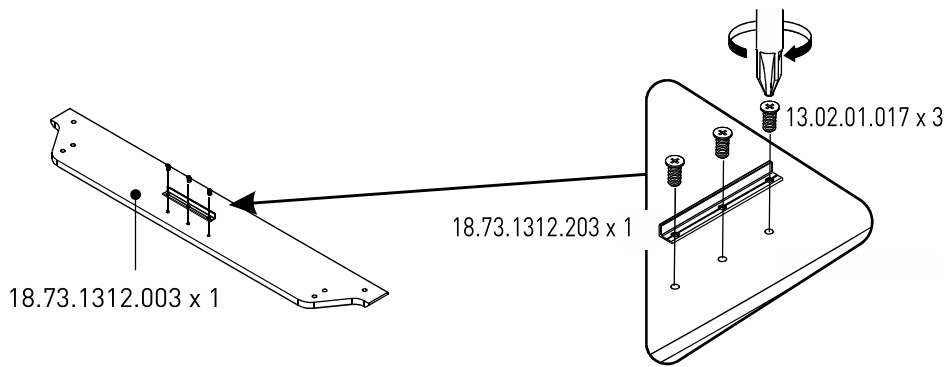

3

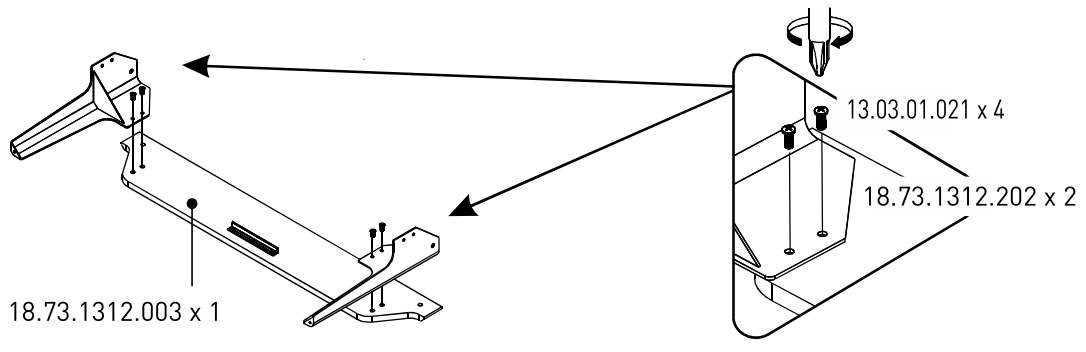

4

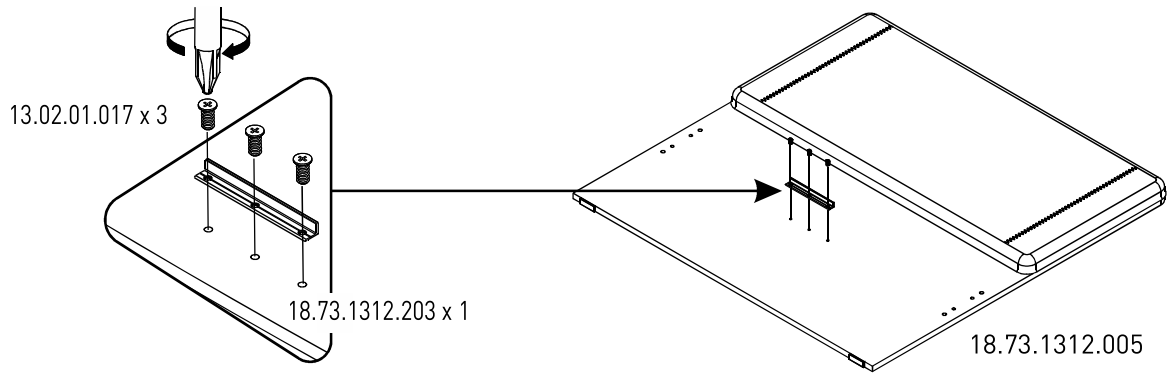

5

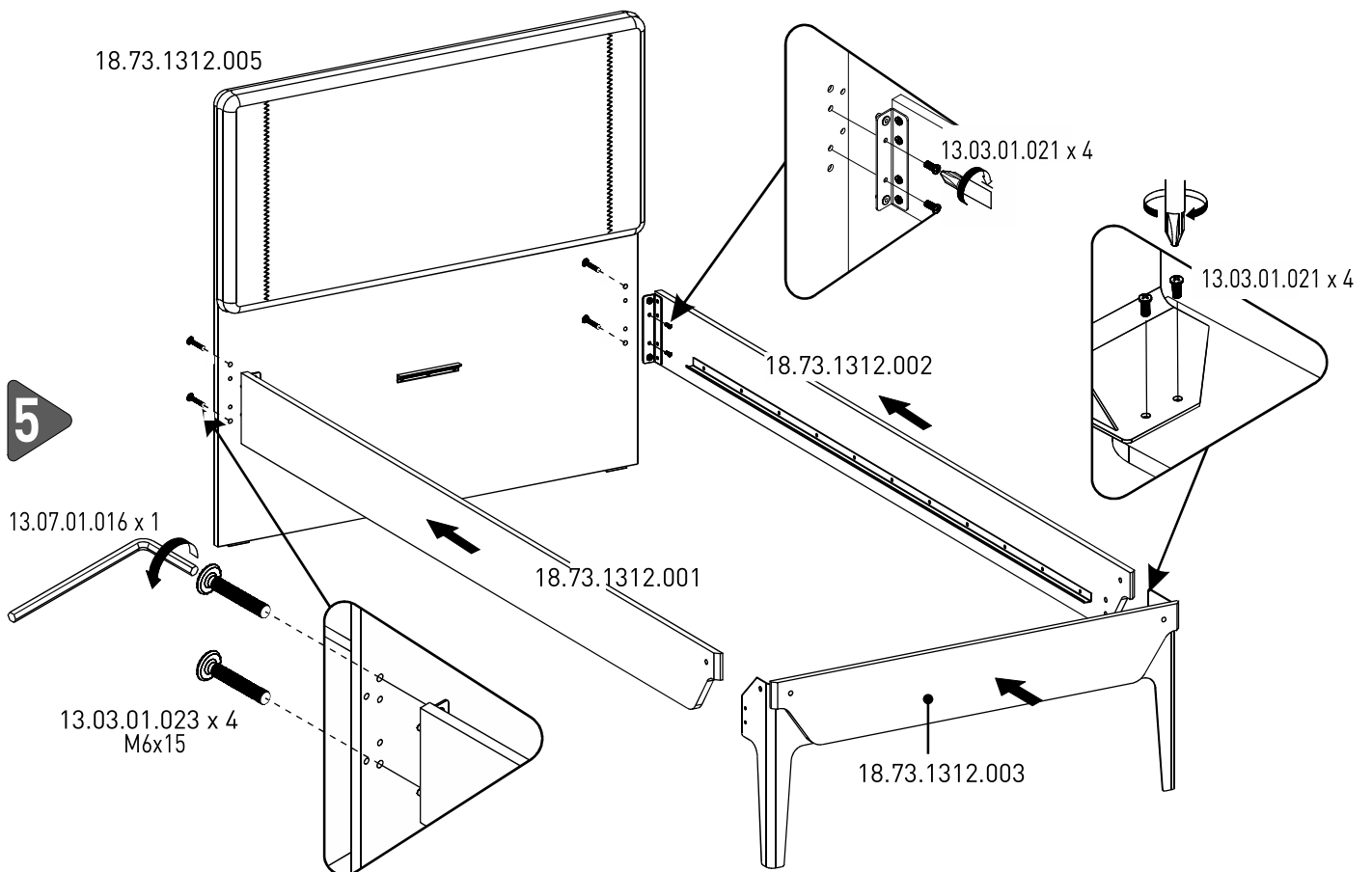

6

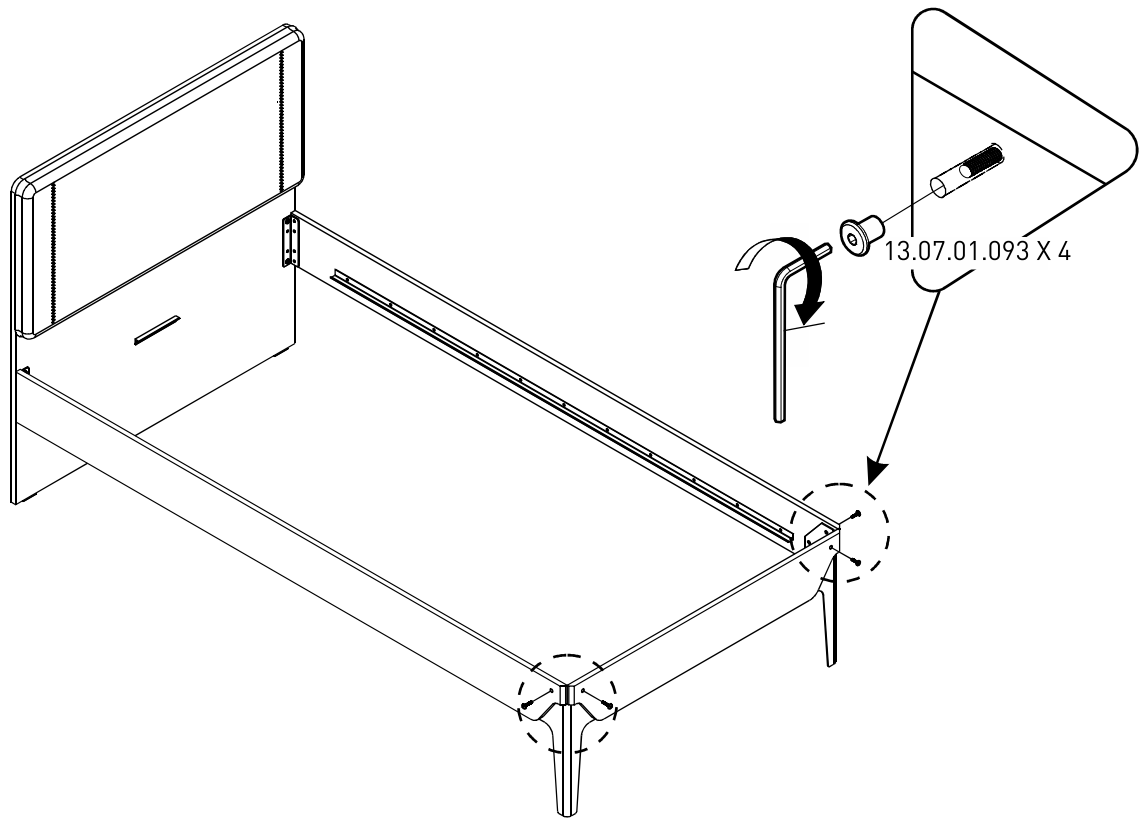

7

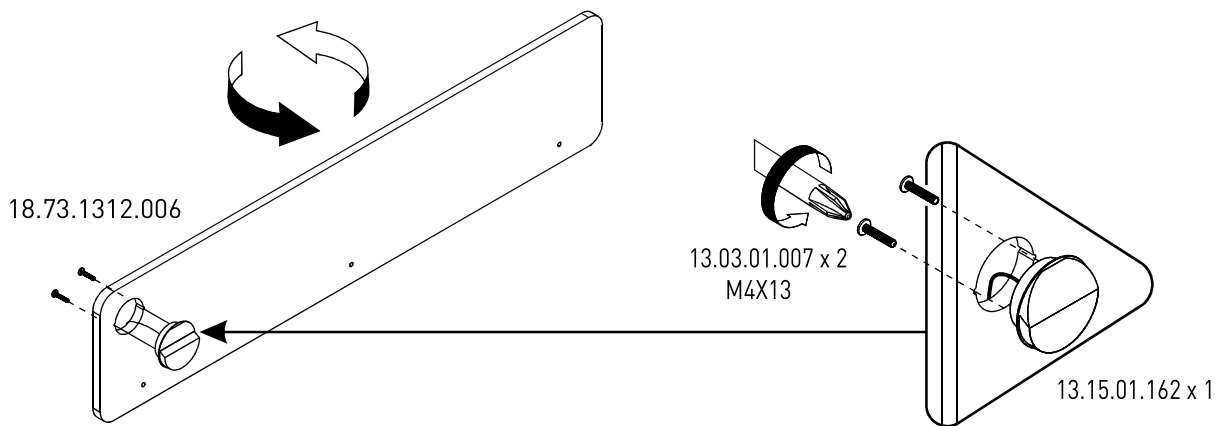

8

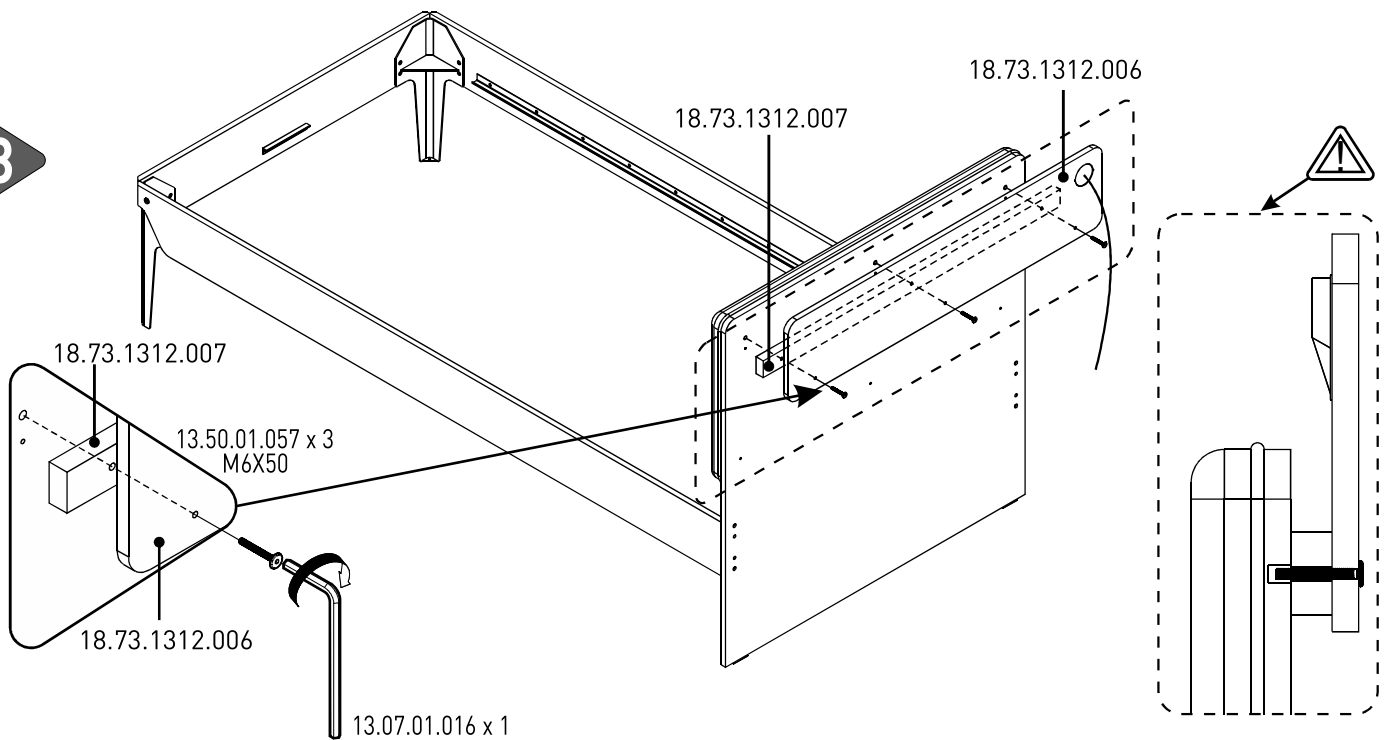

9

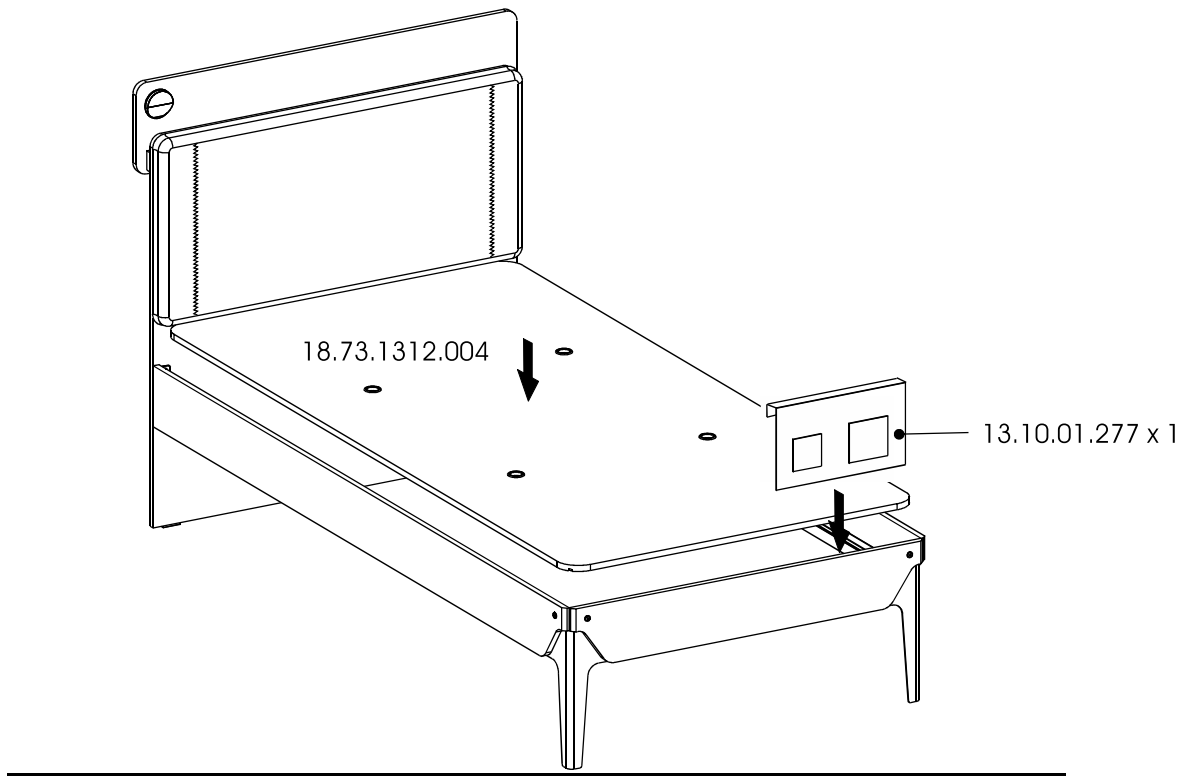

10

